

# Funny Super

Offset flail mower

HP

15 - 35

kW

12 - 25

rpm

540

cm 3-10 - inch 1-4



This offset flail mower has a flexible arm and can mow embankments and close to or under trees and bushes. It is designed for semi-professional use and works well with low HP tractors as it is light and flexible. It can be used to cut grass, weeds and small bushes.

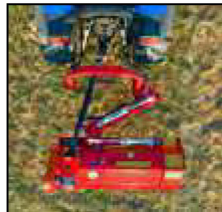
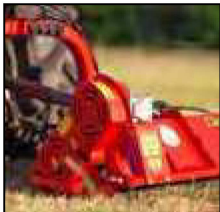

## STANDARD FEATURES

- 3 POINT HITCH, CATEGORY 1 AND 2, HYDRAULIC SIDE SHIFT AND ROTATION
- ALUMINUM GEARBOX 540 RPM WITH INTEGRATED FREE WHEEL DEVICE
- TWO BELT TRANSMISSION WITH ADJUSTABLE TENSIONER
- ROTOR WITH "Y" BLADES OR HAMMERS
- ADJUSTABLE REAR ROLLER (3 POSITIONS)
- UNIVERSAL PTO SHAFT CATEGORY 4 - 1470 MM

Model	N.	hp	cm		in		n.		kg	lbs	Pricing
			cm	in	cm	in	n.	n.	kg	lbs	
Funny Super 106	2C	15 - 35	106	42"	120	48"	32	16	245	540	5,377.00
Funny Super 132	2C	15 - 35	132	52"	155	62"	40	20	260	573	5,577.00

OPTIONAL	Type
----------	------



**C**

Rotor with Y blades for universal use- grass

Funny Super 106 C  
Funny Super 132 C

Type
------



**M**

Rotor with hammers for specific use- raw land, brambles, pruning

Funny Super 106 M  
Funny Super 132 M

cm	106	132
A	57	57
B	97	123
C	154	180
D	130	130
E	187	213
F	100	100

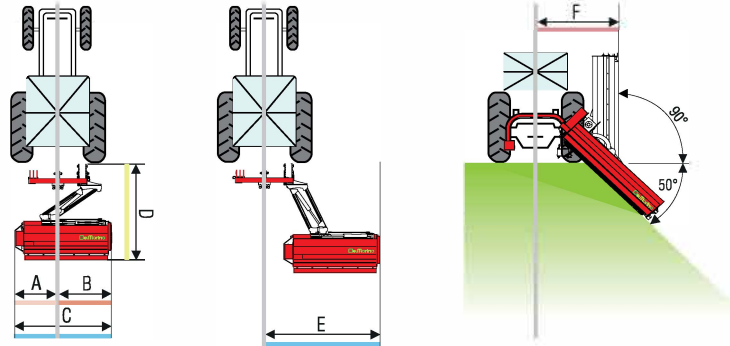

**DIMENSIONS**

Type	A (cm)	B (cm)	C (cm)
Funny Super 106	150	120	80
Funny Super 132	150	150	80

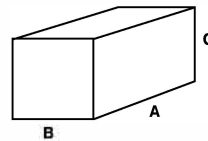

# Centurion Super

Offset flail mower

HP  
15 - 60

kW  
22 - 50

rpm  
540

cm 3-10 - inch 1-4



A practical, multipurpose flail mower for the professional farmer with a flexible arm for mowing embankments, etc. The power transmission system is the best available and is suitable for tractors up to 60 HP. The quality, performance and price are outstanding.



## STANDARD FEATURES

- 3 POINT HITCH CATEGORY 1 AND 2, WITH HYDRAULIC SIDE SHIFT AND ROTATION
- CAST IRON GEAR BOX 540 RPM WITH INTEGRATED FREE WHEEL DEVICE
- 3 BELT DRIVE TRANSMISSION WITH SCREW ADJUSTABLE TENSIONER
- ROTOR WITH BLADES OR HAMMERS
- ADJUSTABLE REAR ROLLER
- UNIVERSAL PTO SHAFT CATEGORY 4 - 1470 MM



Model	N.	hp	cm	in	cm	in	n.	n.	kg	lbs	Pricing
<b>Centurion Super 106</b>	<b>3C</b>	<b>15 - 60</b>	<b>106</b>	<b>42"</b>	<b>120</b>	<b>50"</b>	<b>32</b>	<b>16</b>	<b>290</b>	<b>639</b>	<b>5,904.00</b>
<b>Centurion Super 132</b>	<b>3C</b>	<b>15 - 60</b>	<b>132</b>	<b>52"</b>	<b>155</b>	<b>60"</b>	<b>40</b>	<b>20</b>	<b>350</b>	<b>772</b>	<b>6,207.00</b>
<b>Centurion Super 158</b>	<b>3C</b>	<b>15 - 60</b>	<b>158</b>	<b>62"</b>	<b>195</b>	<b>72"</b>	<b>48</b>	<b>24</b>	<b>372</b>	<b>820</b>	<b>6,403.00</b>

OPTIONAL		Type
----------	--	------



**C**

Rotor with Y blades for universal use- grass

- Centurion Super 106 C
- Centurion Super 132 C
- Centurion Super 158 C

		Type
--	--	------



**M**

Rotor with hammers for specific use- raw land, brambles, pruning

- Centurion Super 106 M
- Centurion Super 132 M
- Centurion Super 158 M

cm	106	132	158
A	60	60	60
B	95	121	147
C	155	181	207
D	148	148	148
E	188	214	240
F	100	100	100

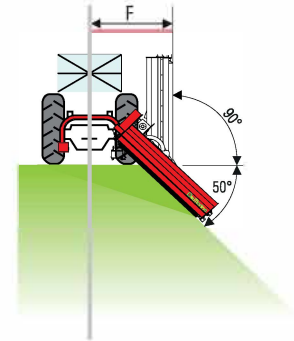
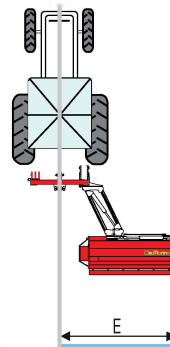
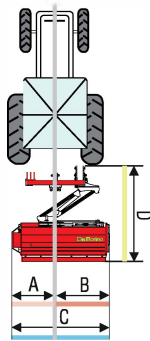

**DIMENSIONS**

Type	A (cm)	B (cm)	C (cm)
Centurion S. 106	<b>150</b>	<b>120</b>	<b>80</b>
Centurion S. 132	<b>150</b>	<b>150</b>	<b>80</b>
Centurion S. 158	<b>180</b>	<b>150</b>	<b>80</b>

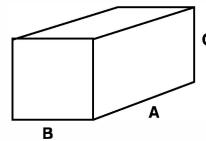

# Flipper Super

Offset flail mower

**HP**  
**50 - 80**

**kW**  
**40 - 60**

**rpm**  
**540**



Suitable for professional, heavy, duty use. Strong, flexible and versatile. It permits an optimal maintenance of embankments, slopes, etc.

## **STANDARD FEATURES**

- 3 POINT HITCH, CATEGORY 1 AND 2 WITH HYDRAULIC SIDE SHIFT
- CAST IRON GEARBOX 540 RPM WITH FREE WHEEL DEVICE
- COUNTERBLADE DEVICE
- REAR LEVELLING ROLLER Ø 160 MM
- HIGH THICKNESS SIDES 6MM
- UNIVERSAL PTO SHAFT CATEGORY 6 - 1800 MM

COD-MOD	N.	hp	cm	in	cm	in	n.	n.	kg	lbs	Pricing
<b>Flipper Super 132</b>	<b>3C</b>	<b>50 - 80</b>	<b>132</b>	<b>52"</b>	<b>158</b>	<b>62"</b>	<b>40</b>	<b>20</b>	<b>470</b>	<b>1036</b>	<b>7,788.00</b>
<b>Flipper Super 158</b>	<b>3C</b>	<b>50 - 80</b>	<b>158</b>	<b>62"</b>	<b>184</b>	<b>72"</b>	<b>48</b>	<b>24</b>	<b>492</b>	<b>1085</b>	<b>8,257.00</b>
<b>Flipper Super 186</b>	<b>3C</b>	<b>50 - 80</b>	<b>186</b>	<b>72"</b>	<b>210</b>	<b>82"</b>	<b>56</b>	<b>28</b>	<b>515</b>	<b>1135</b>	<b>8,874.00</b>

OPTIONAL



**C**

Rotor with Y blades for universal use- grass



**M**

Rotor with hammers for specific use- raw land, brambles, pruning

Model

Pricing



**S**

Skid Kit for heavy wear situations

**221.00**

Model

Pricing

**O**

Wide angle PTO shaft - closed curves

**723.00**

cm	132	158	186
A	76	76	76
B	82	108	134
C	158	184	210
D	210	210	210
E	198	224	250
F	134	134	134

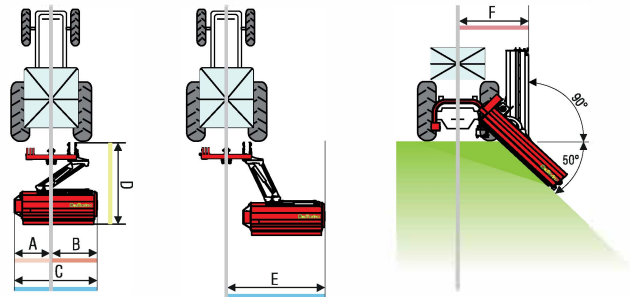

DIMENSIONS

Type	A (cm)	B (cm)	C (cm)
Flipper Super 132	<b>160</b>	<b>120</b>	<b>200</b>
Flipper Super 158	<b>190</b>	<b>120</b>	<b>200</b>
Flipper Super 186	<b>220</b>	<b>120</b>	<b>200</b>

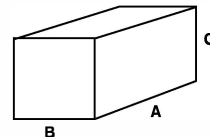

PACKAGING

Single metal crate

\$167.00



# Levante Super

Offset flail mower

**HP**  
**80 - 120**

**kW**  
**60 - 90**

**rpm**  
**540 / 1000**



Suitable for professional, heavy duty use. Strong, flexible and versatile. It permits an optimal maintenance of embankments, slopes, etc.

#### STANDARD FEATURES

- 3 POINT HITCH, CATEGORY 2 AND 3 WITH HYDRAULIC SIDE SHIFT
- TRANSMISSION BY 4 HEAVY-DUTY BELTS
- COUNTERBLADE DEVICE
- HIGH THICKNESS SIDES (10 MM)
- COUNTERBLADE DEVICE
- REAR LEVELLING ROLLER Ø 160 MM
- WIDE DISCHARGE AREA
- UNIVERSAL PTO SHAFT CATEGORY 6 - 1800 MM



Model	n.	hp	cm	in	cm	in	n.	n.	cm	in	kg	lbs	Pricing
<b>Levante Super 160</b>	<b>4C</b>	<b>80 - 120</b>	<b>160</b>	<b>63"</b>	<b>180</b>	<b>71"</b>	<b>48</b>	<b>24</b>	<b>2-12</b>	<b>1-5</b>	<b>720</b>	<b>1588</b>	<b>10,531.00</b>
<b>Levante Super 190</b>	<b>4C</b>	<b>80 - 120</b>	<b>190</b>	<b>75"</b>	<b>208</b>	<b>82"</b>	<b>56</b>	<b>28</b>	<b>2-12</b>	<b>1-5</b>	<b>757</b>	<b>1669</b>	<b>11,248.00</b>
<b>Levante Super 220</b>	<b>4C</b>	<b>80 - 120</b>	<b>220</b>	<b>87"</b>	<b>236</b>	<b>93"</b>	<b>64</b>	<b>32</b>	<b>2-12</b>	<b>1-5</b>	<b>795</b>	<b>1753</b>	<b>12,030.00</b>

OPTIONAL



**C**

Rotor with Y blades for universal use- grass



**M**

Rotor with hammers for specific use- raw land, brambles, pruning

Cod.

Pricing



**ER**

Extension Kit for rear roller

**212.00**

Cod.

Pricing



**S**

Skid Kit for heavy wear situations

**221.00**

cm	160	190	220
A	85	85	85
B	106	132	158
C	191	217	243
D	194	194	194
E	229	255	281
F	135	135	135

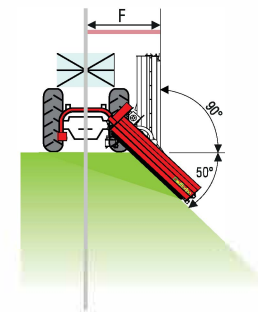
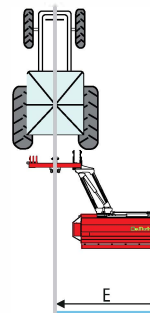
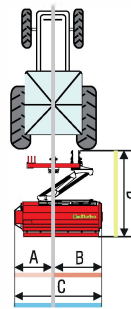

DIMENSIONS

Type	A (cm)	B (cm)	C (cm)
Levante Super 160	<b>190</b>	<b>120</b>	<b>200</b>
Levante Super 190	<b>220</b>	<b>120</b>	<b>200</b>
Levante Super 220	<b>250</b>	<b>120</b>	<b>200</b>

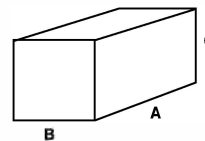

PACKAGING

Single metal crate

\$167.00

